

COMMON LABORATORY EQUIPMENT

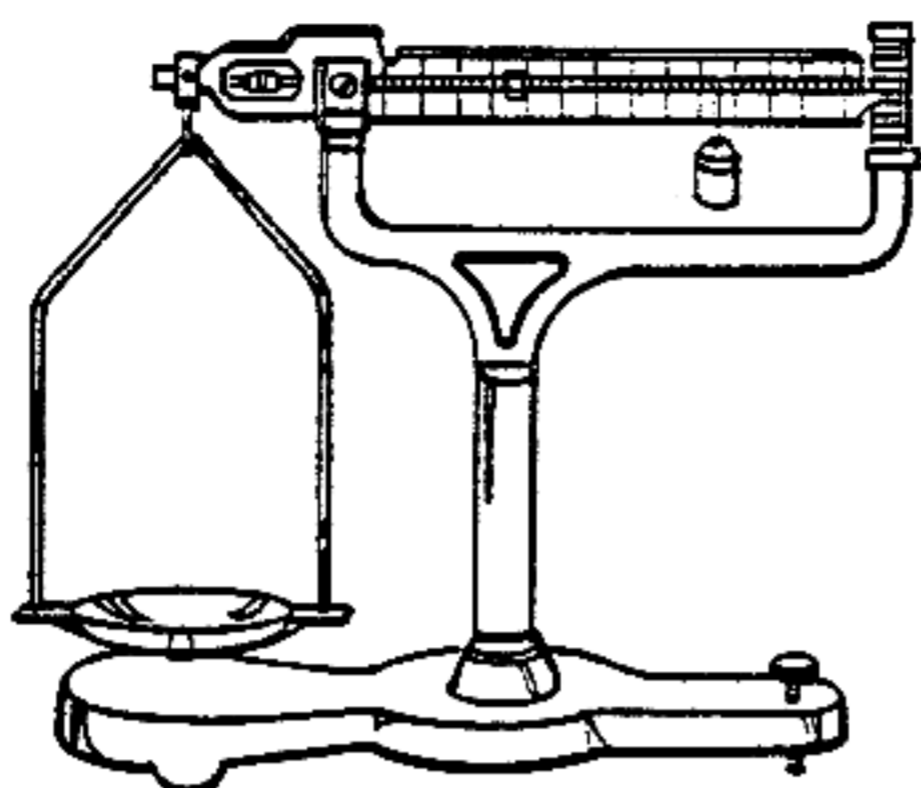

ceramic  
tile



Triple-beam balance

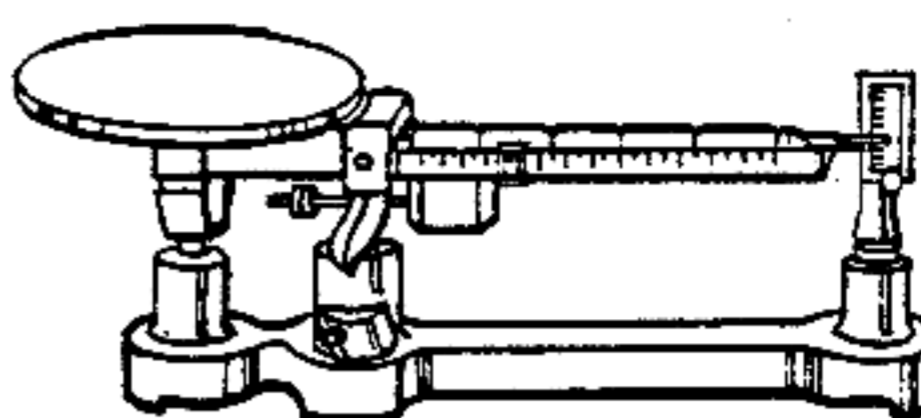

Platform balance

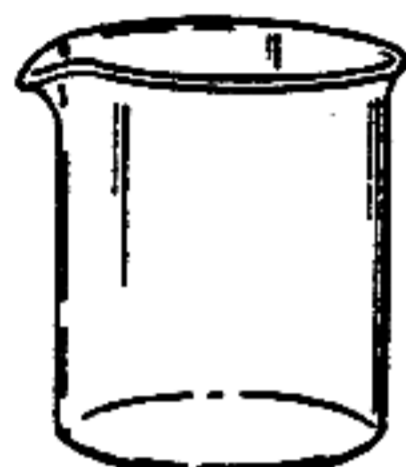

Beaker



Wide mouth bottle

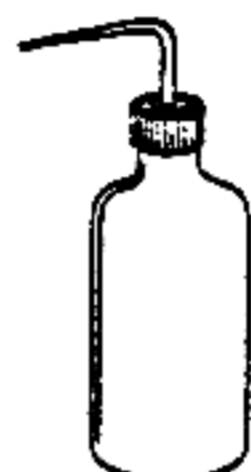

polyethylene  
wash bottle



Burets



Deflagration spoon



test tube brush



Pinchcock clamp



Crucible and cover



Screw clamp

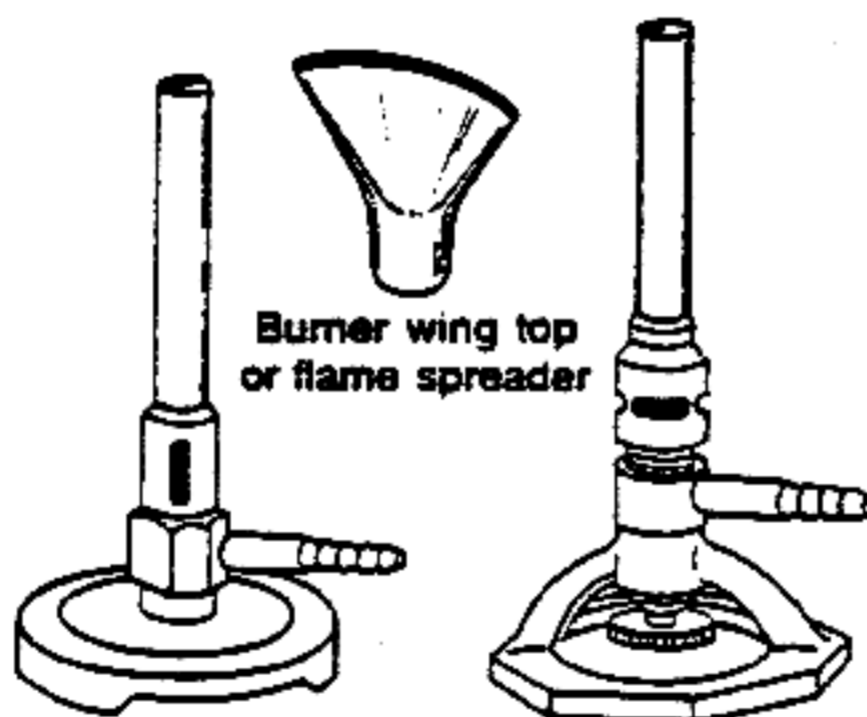

Burner wing top  
or flame spreader

Laboratory burners



Evaporating dish

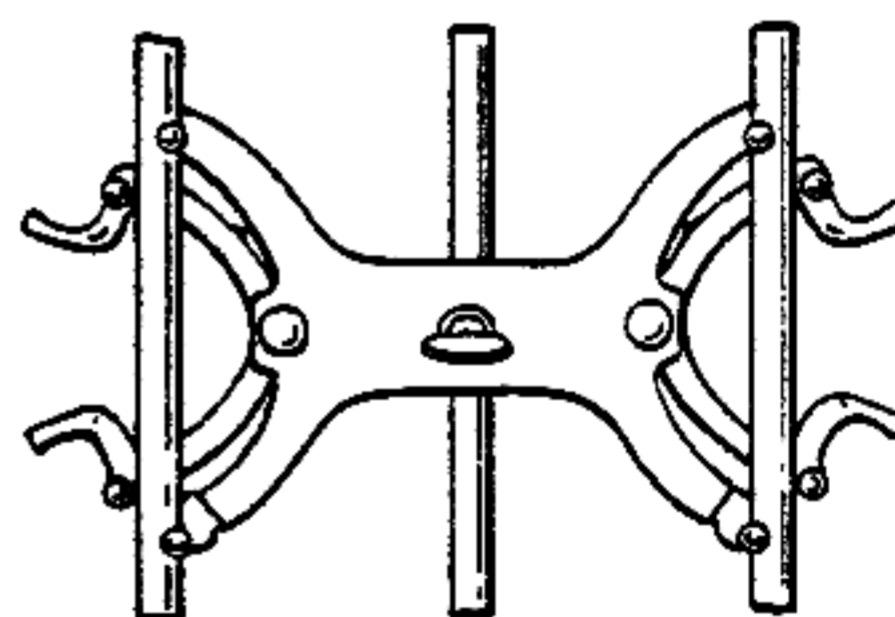

Buret clamp

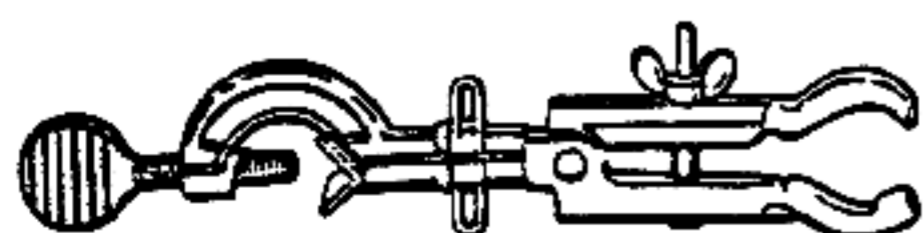

Utility clamp

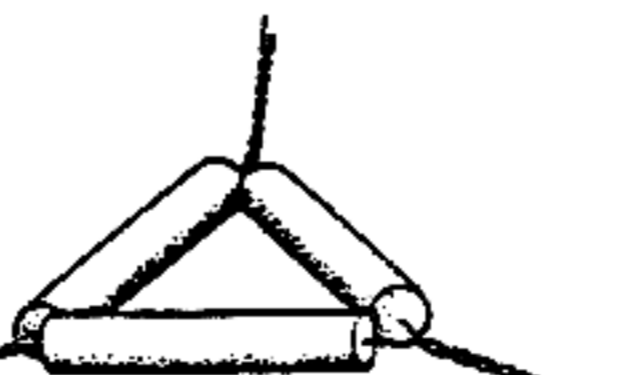

Clay triangle



Test tube clamp



Erlenmeyer flask



Florence flask

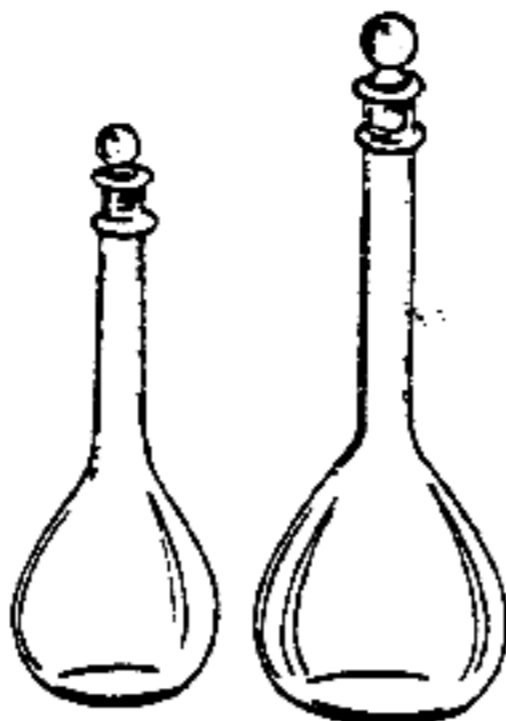

Volumetric flasks



Triangular file



Forceps (tweezers)



Funnel

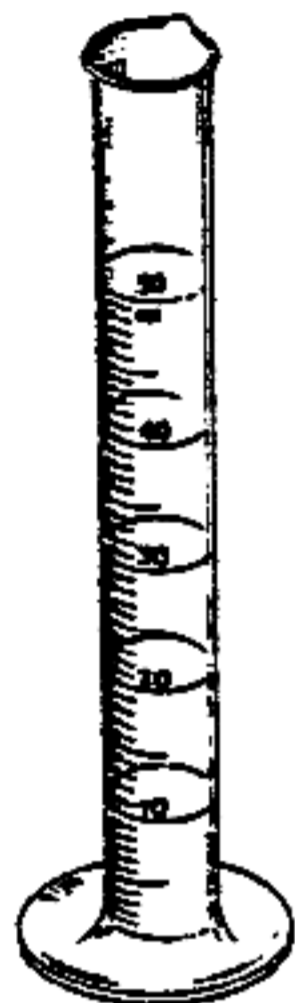

Graduated cylinder



Glass plate



Mortar and pestle



Gas Measuring Tube



Pipets

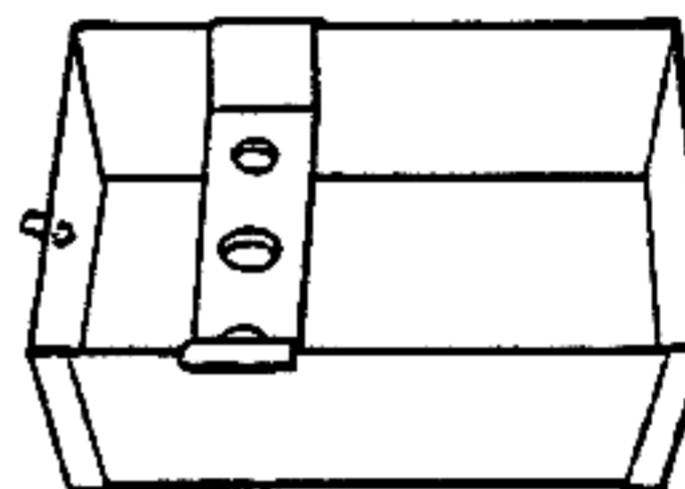

Pneumatic-trough



Spatula



Stirring rod



Thermometer

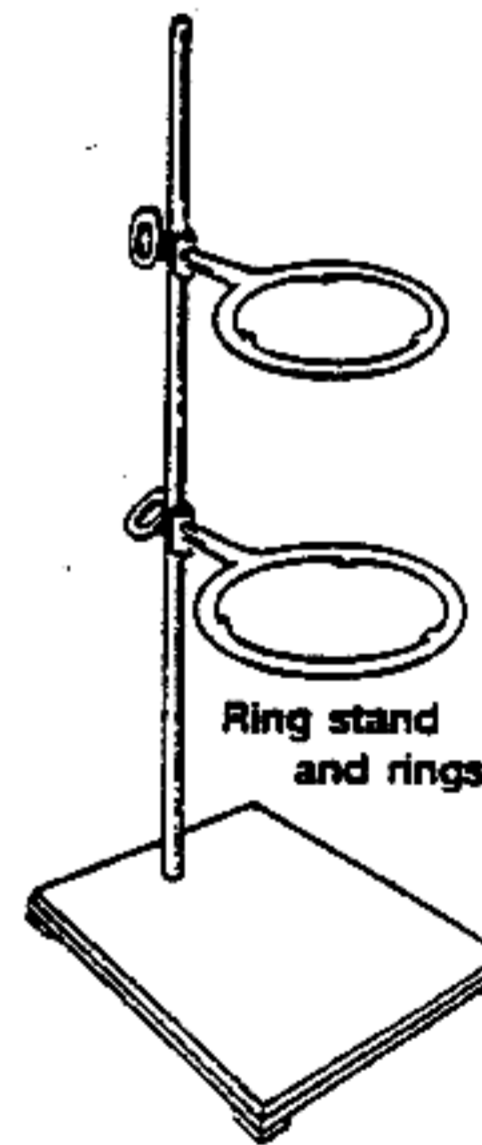

Ring stand and rings

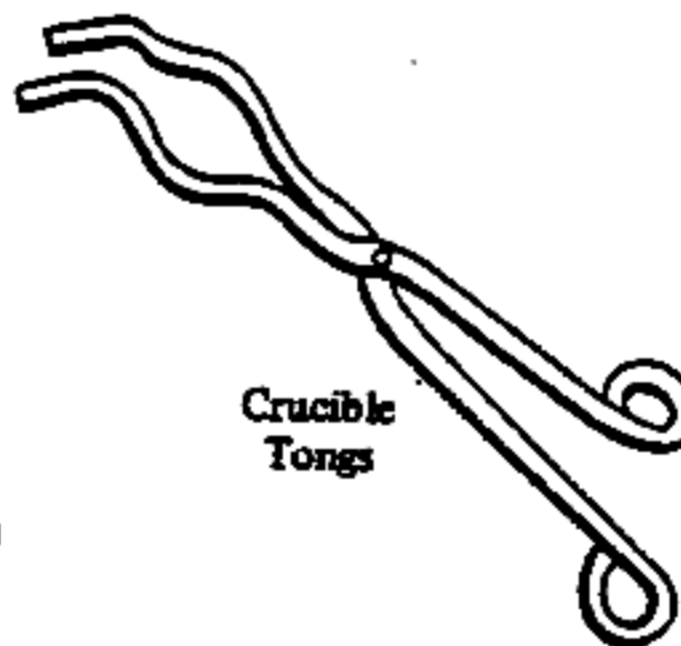

Crucible Tongs

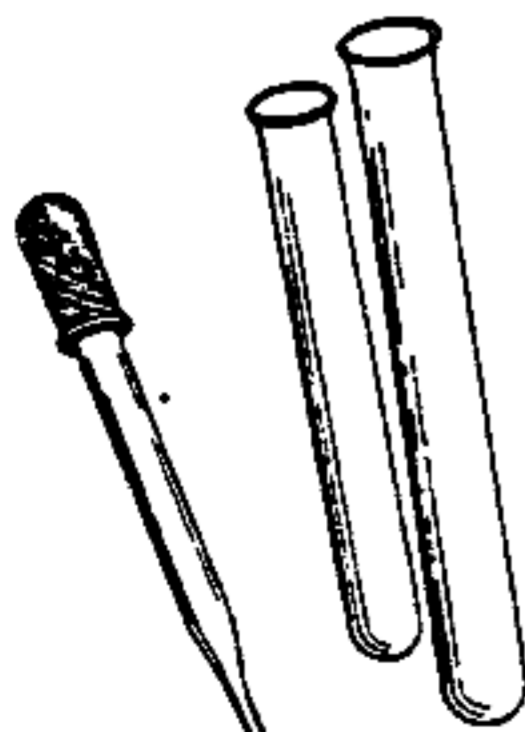

Medicine dropper

Test tubes

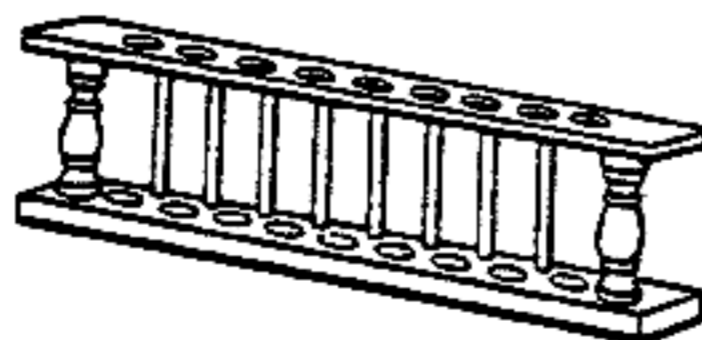

Test tube rack



Watch glass

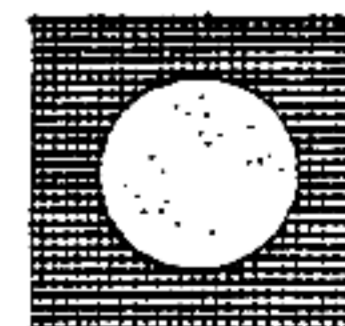

wire gauze